

CS GELENKCOOG MET SFERISCH LAGER / EMBOUT À ROTULE SPHERIQUE - ISO 6982

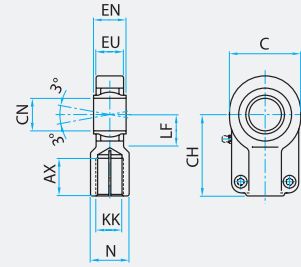
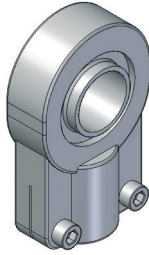

Code / Code	CS 12125	CS 1415	CS 1615	CS 2015	CS 272	CS 332	CS 422	CS 482	CS 643	CS 723	CS 803	CS 1003	CS 1254	CS 1604
AX	17	19	23	29	37	46	57	64	86	91	96	113	126	161
C	32	40	47	58	70	89	108	132	168	185	212	264	326	418
CH	38	44	52	65	80	97	120	140	180	195	210	260	310	390
CN	12	16	20	25	32	40	50	63	80	90	100	125	160	200
EN	12	16	20	25	32	40	50	63	80	90	100	125	160	200
EU	10.5	13	17	21	27	32	40	52	66	72	85	103	130	167
KK	M12x1.25	M14x1.5	M16x1.5	M20x1.5	M27x2	M33x2	M42x2	M48x2	M64x3	M72x3	M80x3	M100x3	M125x4	M160x4
LF	14	18	22	27	32	41	50	62	78	85	98	120	150	195
N	16	21	25	30	38	47	58	70	90	100	110	135	165	215
(Kg)	0.11	0.20	0.36	0.62	1.16	2.16	3.84	7.24	13.20	17.50	28.0	46.40	81	174

* Geschikt voor cilinders met standaard stangeinde.
* Approprié pour vérins avec extrémité de tige standard.

TS GELENKCOOG MET SFERISCH LAGER / EMBOUT À ROTULE SPHERIQUE - DIN 24555

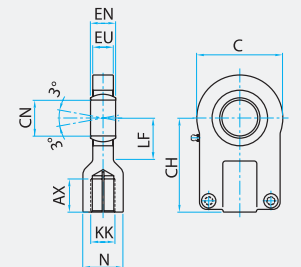
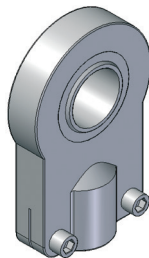

Code / Code	TS 10125	TS 12125	TS 1415	TS 1615	TS 2015	TS 272	TS 332	TS 422	TS 482	TS 643
AX	15	17	19	23	29	37	46	57	64	86
C	32	42	50	62	76	96	116	150	195	235
CH	42	48	58	68	85	105	130	150	185	240
CN	12	16	20	25	30	40	50	60	80	100
EN	10	14	16	20	22	28	35	44	55	70
EU	8	11	13	17	19	23	30	38	47	57
KK	M10x1.25	M12x1.25	M14x1.5	M16x1.5	M20x1.5	M27x2	M33x2	M42x2	M48x2	M64x3
LF	18	22	28	34	38	48	62	74	98	122
N	17	21	25	30	36	45	55	68	78	100
(Kg)	0.13	0.23	0.39	0.70	1.22	2.14	3.96	7.26	14.60	25.40

* Geschikt voor cilinders met SL stangeinde ("SL" moet gespecificeerd worden in de bestelcode)
* Approprié pour vérins avec extrémité de la tige SL ("SL" doit être spécifié dans la codification pour la commande du vérin).

CF GAFFEL MET PIN / EXTRÉMITÉ AVEC CHAPE ET AXE - ISO 8133

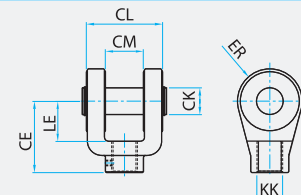
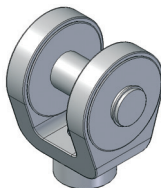

Code / Code	CF 10125	CF 12125	CF 1415	CF 1615	CF 2015	CF 272	CF 332	CF 422	CF 482	CF 643	CF 803
CE	32	36	38	54	60	75	99	113	126	168	168
CK	10	12	14	20	20	28	36	45	56	70	70
CL	24	32	40	60	60	80	100	120	140	160	160
CM	12	16	20	30	30	40	50	60	70	80	80
ER	12	17	17	29	29	34	50	53	59	78	78
KK	M10x1.25	M12x1.25	M14x1.5	M16x1.5	M20x1.5	M27x2	M33x2	M42x2	M48x2	M64x3	M80x3
LE	13	19	19	32	32	39	54	57	63	83	83
(Kg)	0.10	0.18	0.25	0.88	0.92	1.90	4.92	6.52	10.04	19.50	19.50

LD TAPBEUGELS HOEK / SUPPORT DE CHAPE FEMELLE EN ANGLE - ISO 8133 / DIN 24556

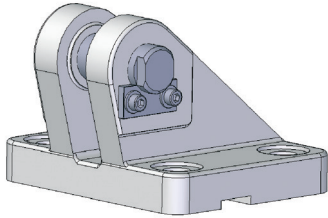

Voor cilinders met bevestiging D
Pour vérins avec fixation D

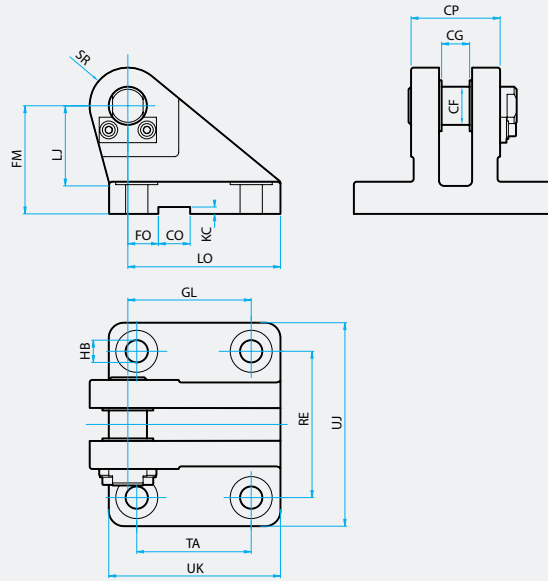

Code / Code	CF H6	CG	CO N9	CP H14	FM js11	FO js14	GL js13	HB	KC	LJ	LO	RE js13	SR	TA js13	UJ	UK
LD25	12	10	10	30	40	16	46	9	3.3	29	56	55	12	40	75	60
LD32	16	14	16	40	50	18	61	11	4.3	38	74	70	16	55	95	80
LD40	20	16	16	50	55	20	62	13.5	4.3	40	80	85	20	58	120	90
LD50	25	20	25	60	65	22	78	15.5	5.4	49	98	100	25	70	140	110
LD63	30	22	25	70	85	24	97	17.5	5.4	63	120	115	30	90	160	135
LD80	40	28	36	80	100	24	123	22	8.4	73	148	135	40	120	190	170
LD100	50	35	36	100	125	35	155	30	8.4	92	190	170	50	145	240	215
LD125	60	44	50	120	150	35	187	39	11.4	110	225	200	60	185	270	260
LD160	80	55	50	160	190	35	255	45	11.4	142	295	240	80	260	320	340
LD200	100	70	63	200	210	35	285	48	12.4	152	335	300	100	300	400	400

3

LK TAPBEUGELS RECHT / CHAPE À TOURILLON - ISO 8132

Geleverd per paar
Livrés par paire.

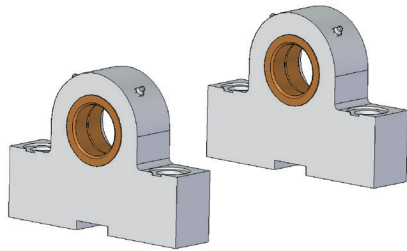

Voor cilinders met bevestigingen G, H, L
Pour vérins avec fixation G, H, L

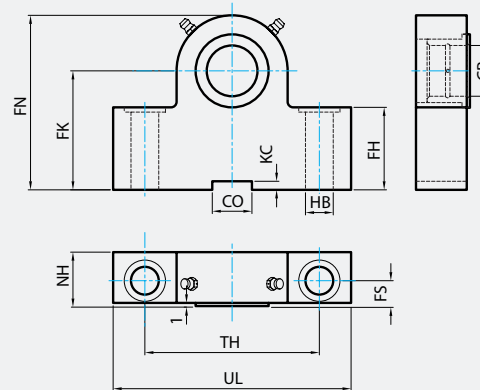

Code / Code	CO N9	CR H7	FH	FK js12	FN	FS js14	HB	KC	NH	TH js14	UL
LK25	10	12	25	34	49	8	9	3.3	17	40	63
LK32	16	16	30	40	59	10	11	4.3	21	50	80
LK40	16	20	38	45	69	10	11	4.3	21	60	90
LK50	25	25	45	55	80	12	13.5	5.4	26	80	110
LK63	25	32	52	65	100	15	17.5	5.4	33	110	150
LK80	36	40	60	76	120	16	22	8.4	41	125	170
LK100	36	50	75	95	140	20	26	8.4	51	160	210
LK125	50	63	85	112	177	25	33	11.4	61	200	265
LK160	50	80	112	140	220	31	39	11.4	81	250	325